

ACCESSORY PRODUCT DATA SHEET

Part #: AT2472AL-0001, AT2472AL-0002, AT2472AL-0003, AT2472AL-0004, AT2472AL-0005, AT2472AL-0006

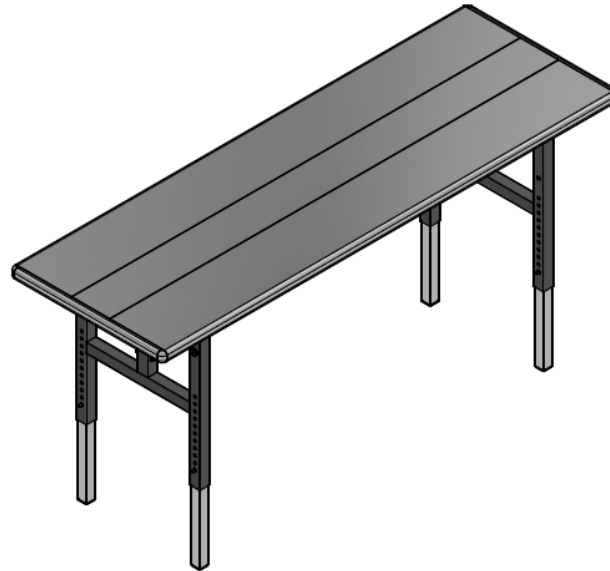

24 INCHES X 72 INCHES X 24.75 - 34.75 INCHES CELINA ALUMINUM TABLE, H STYLE ADJUSTABLE LEGS

CONTRACTOR NAME:	Celina Tent Inc. (CELINA)	
MANUFACTURING SOURCE COMPANY:	Celina Tent Inc. (CELINA)	
PART NUMBER OR NSN:	Part #'s listed in Special/Additional Features	
SPECIFICATIONS AS APPLICABLE:		
DIMENSIONS:	Width: 24 Inches, Length: 72 Inches, Height: 24.75 - 34.75 Inches	
WEIGHT (UNPACKAGED) (lb):	40 lb	
COLOR:	Black, tan, or clear anodized	
SPECIAL/ADDITIONAL FEATURES:	<ul style="list-style-type: none"> • Holds up to 3,800 lb of evenly distributed weight on specific models • All weather aluminum construction • H style adjustable black legs • Surfaces can be easily sanitized • Superior durability verses wood or resin tables • Smooth round edges • Easy to carry • Fireproof 	
	PART #'S	DESCRIPTION
	AT2472AL-0001	Clear anodize finish top
	AT2472AL-0002	Clear anodize finish top with electrical cord knockout and cover
	AT2472AL-0003	Tan painted top
	AT2472AL-0004	Tan painted top with electrical cord knockout and cover
	AT2472AL-0005	Black painted top
	AT2472AL-0006	Black painted top with electrical cord knockout and cover